

**SEWING MACHINE TABLE**  
**COMFORT 2 (C2L, C2XL)**  
**СТОЛ ДЛЯ ШВЕЙНОЙ МАШИНЫ**



# ***SYMBOLS***



***ATTENTION***

***ВНИМАНИЕ***



***ASSEMBLY & ADJUSTMENT***

***СБОРКА РЕГУЛИРОВКА***



***OPERATION***

***ЭКСПЛУАТАЦИЯ***



***STORAGE***

***ХРАНЕНИЕ***

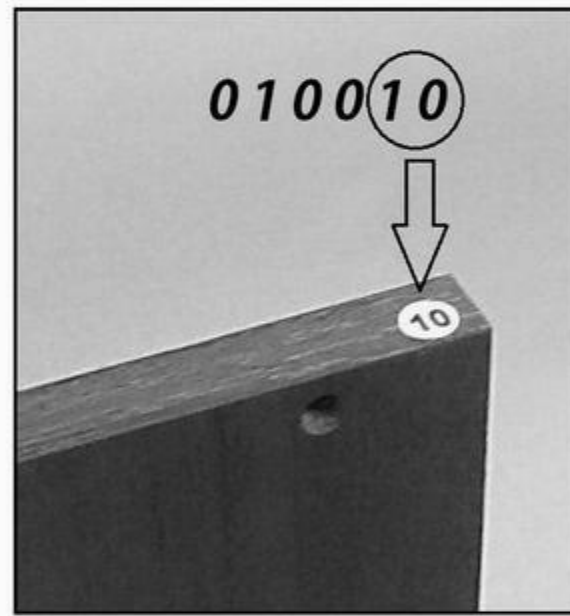

***INDICATING MARK***

***ОБОЗНАЧЕНИЕ***

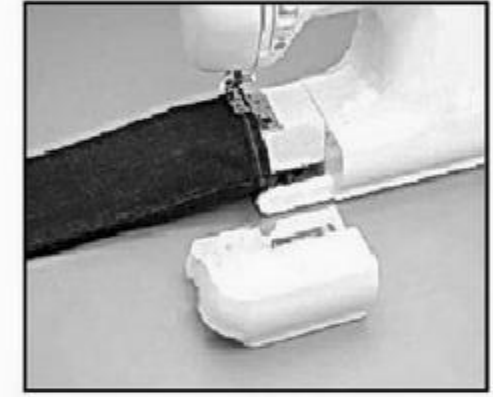

***SPECIAL OPERATION***

***СПЕЦИАЛЬНЫЕ ОПЕРАЦИИ***

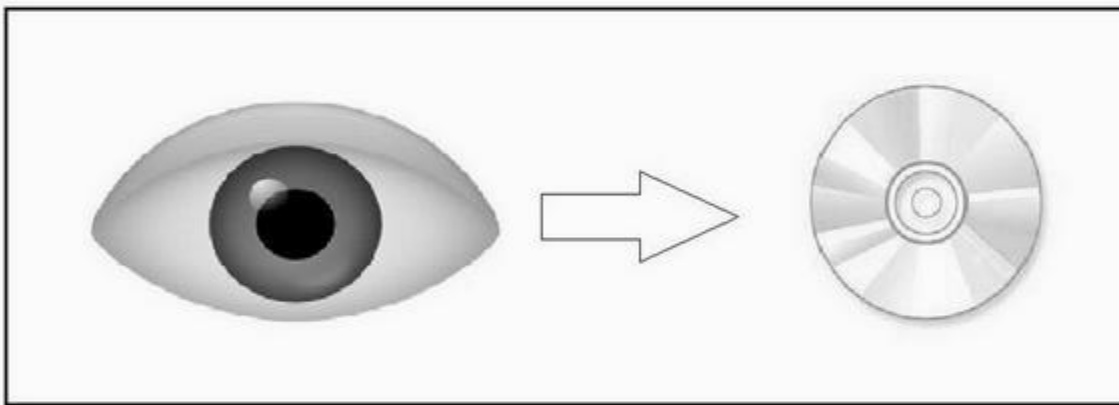

***WATCH DVD***

***СМОТРЕТЬ DVD***

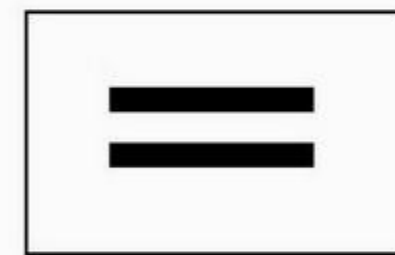

***EQUALITY***

***РАВЕНСТВО***

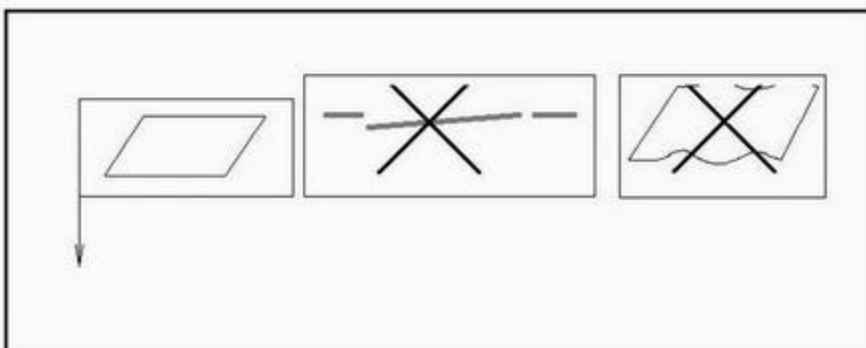











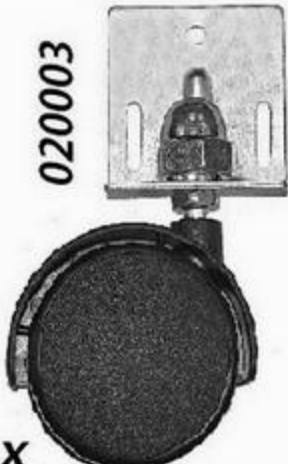

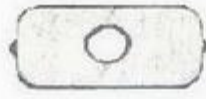







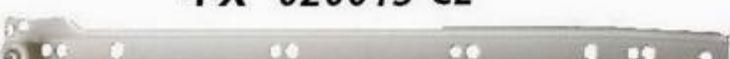











***EVEN SURFACE***

***РОВНАЯ ПОВЕРХНОСТЬ***



010001 1x	010002 1x	010003 1x	010004 1x	010006 1x	010007 1x
010008 1x	010009 1x	010010 1x	010011 3x	010012 3x	010013 3x
010014 1x	010016 1x	010028 1x	010041 1x		

 <b>020001</b> 4 x		 <b>020002</b> 2 x		 <b>020003</b> 1 x		 <b>020004</b> 1 x		 <b>020005</b> 1 x	
 <b>020006</b> 5 x		 <b>020008</b> 1 x		 <b>020010</b> L 660 1 x		 <b>020011</b> 1 x		 <b>020012</b> 1 x	
 4 x 020015 DR				 4 x 020015 DL					
 4 x 020013 CR				 4 x 020013 CL					
 1 x 020007				 4 x 020016					
 <b>030001</b> 3 * 16 39 x	 <b>030002</b> 3,5 * 16 41 x	 <b>030003</b> 6,2 * 50 16 x	 <b>030004</b> φ5 * 30 6 x	 <b>030005</b> 4,2 * 16 25 x	 <b>030006</b> 2,9 * 13 4 x				
 <b>030007</b> φ6 2 x	 <b>030008</b> φ4 10 x	 <b>030009</b> M4 * 20 10 x	 <b>030010</b> φ6 4 x	 <b>030011</b> φ15 16 x	 <b>030012</b> φ18 9 x				
 <b>030013</b> L = 35 9 x	 <b>030014</b> φ15 h12 9 x	 <b>030015</b> φ8 * 30 16 x	 <b>030016</b> φ8 * 30 6 x	 <b>030017</b> φ15 h12 6 x	 <b>030027</b> M4 * 35 2 x				



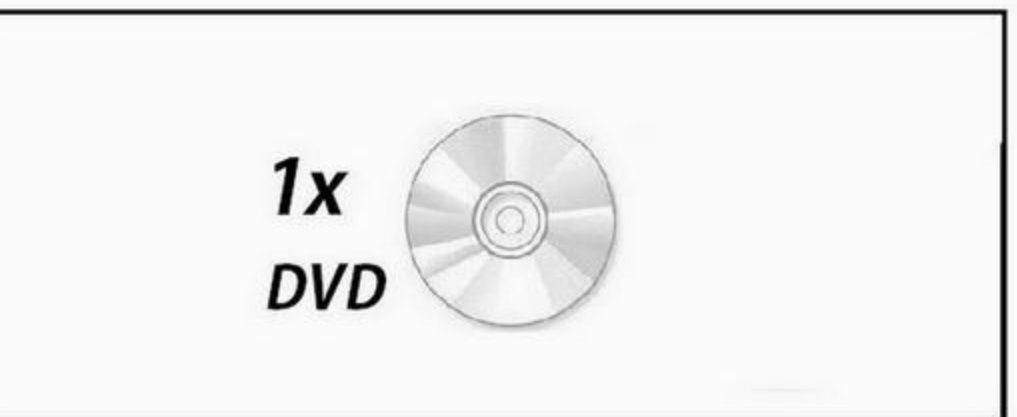
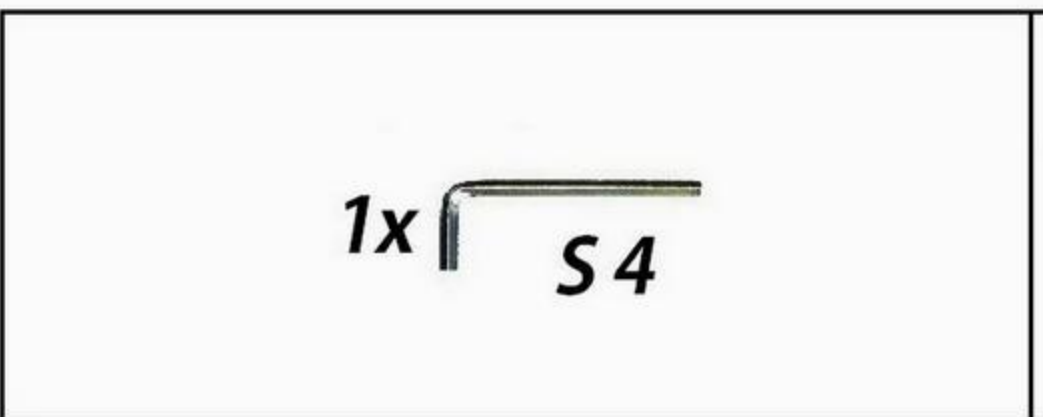
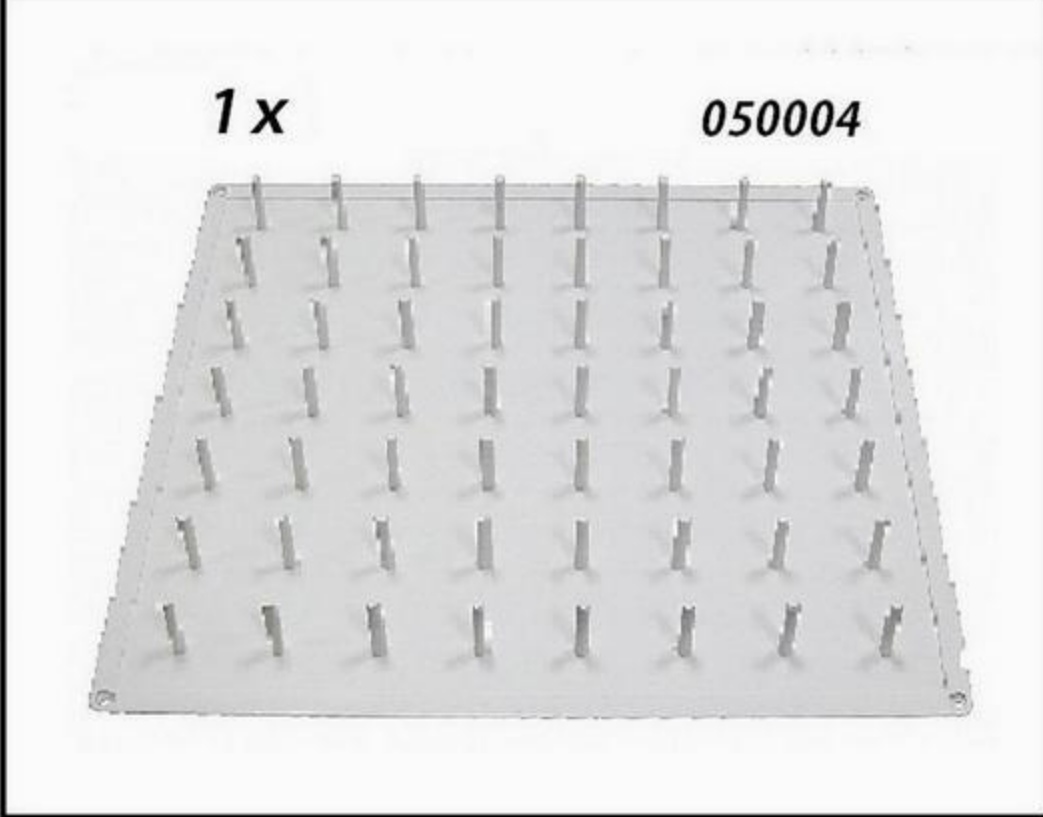
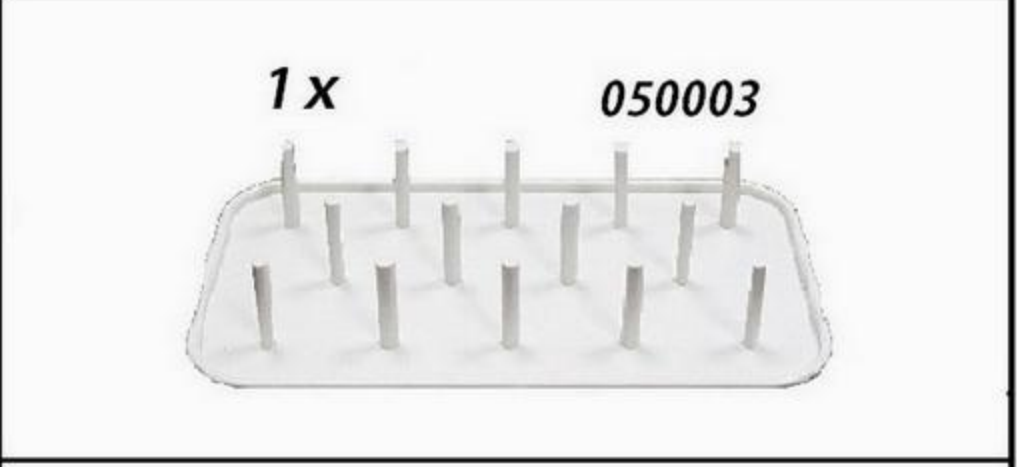
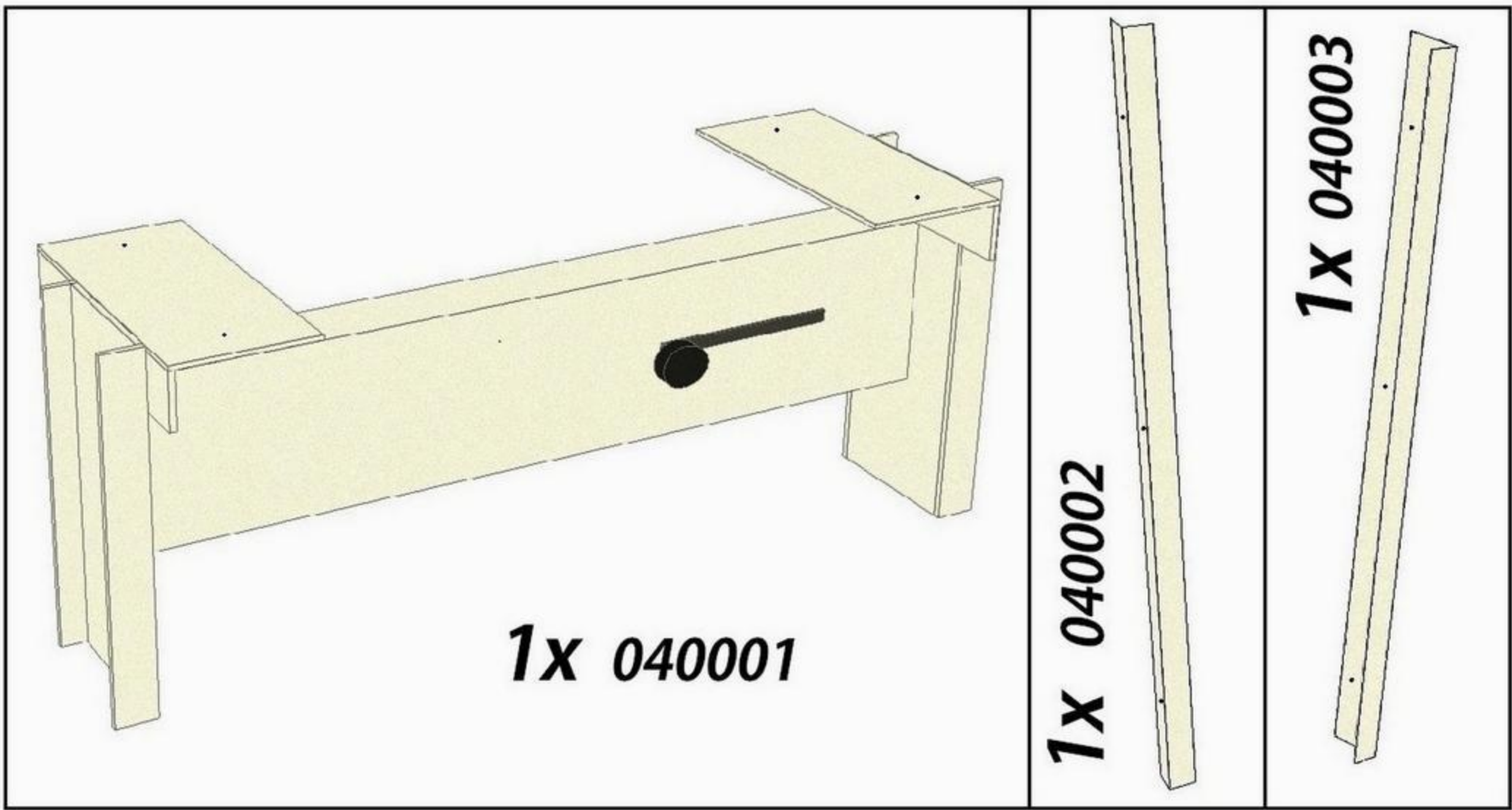



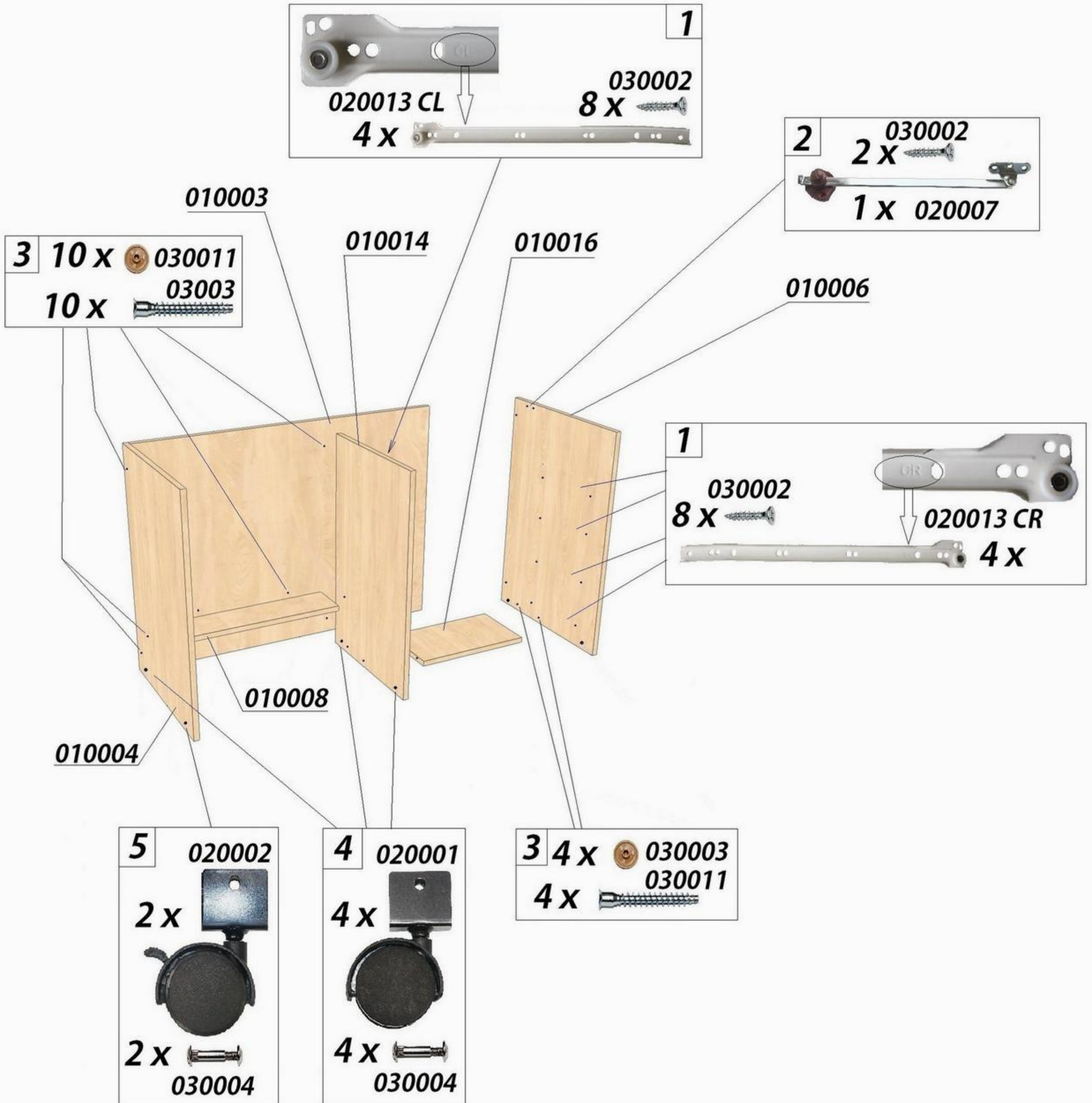



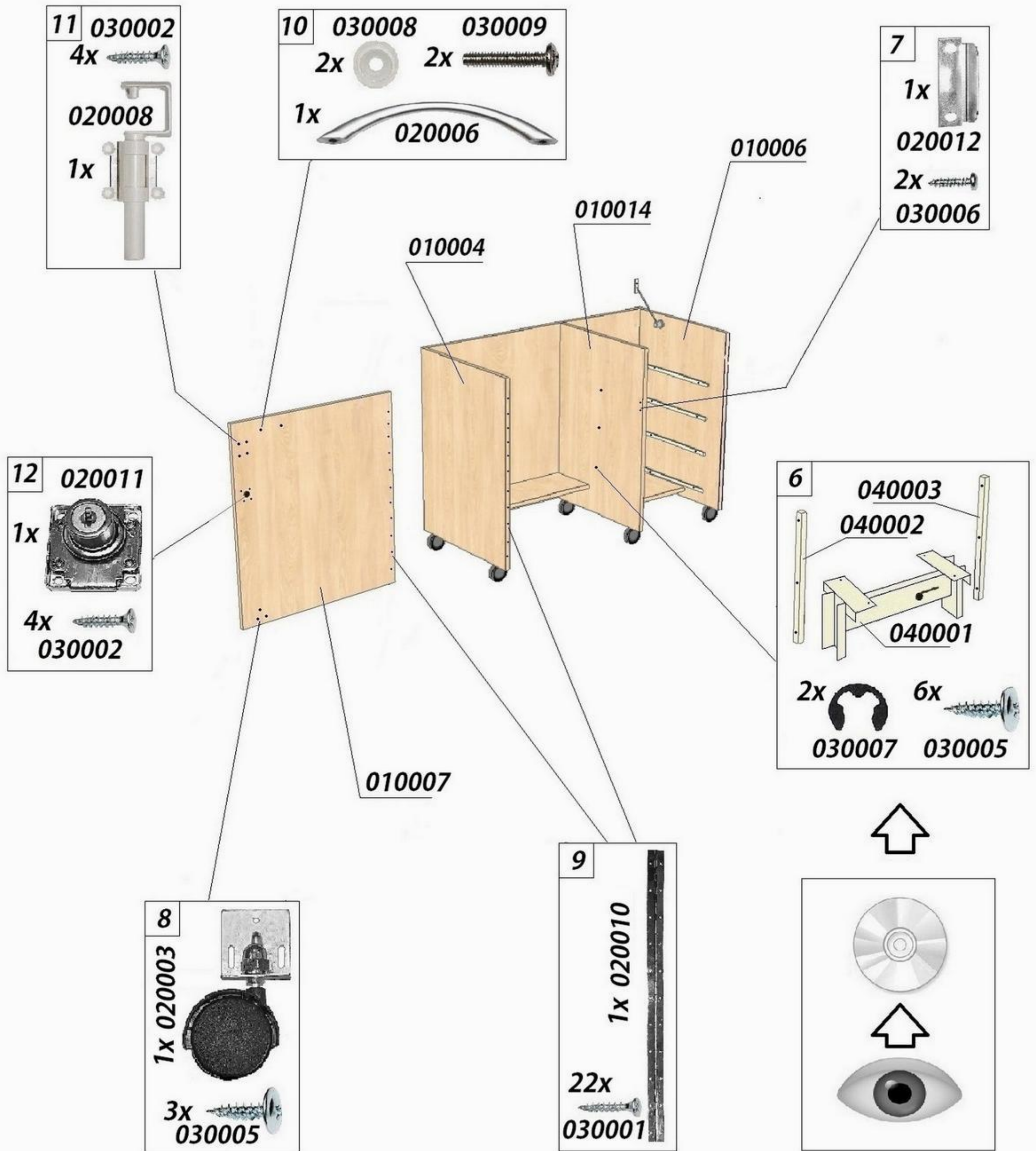

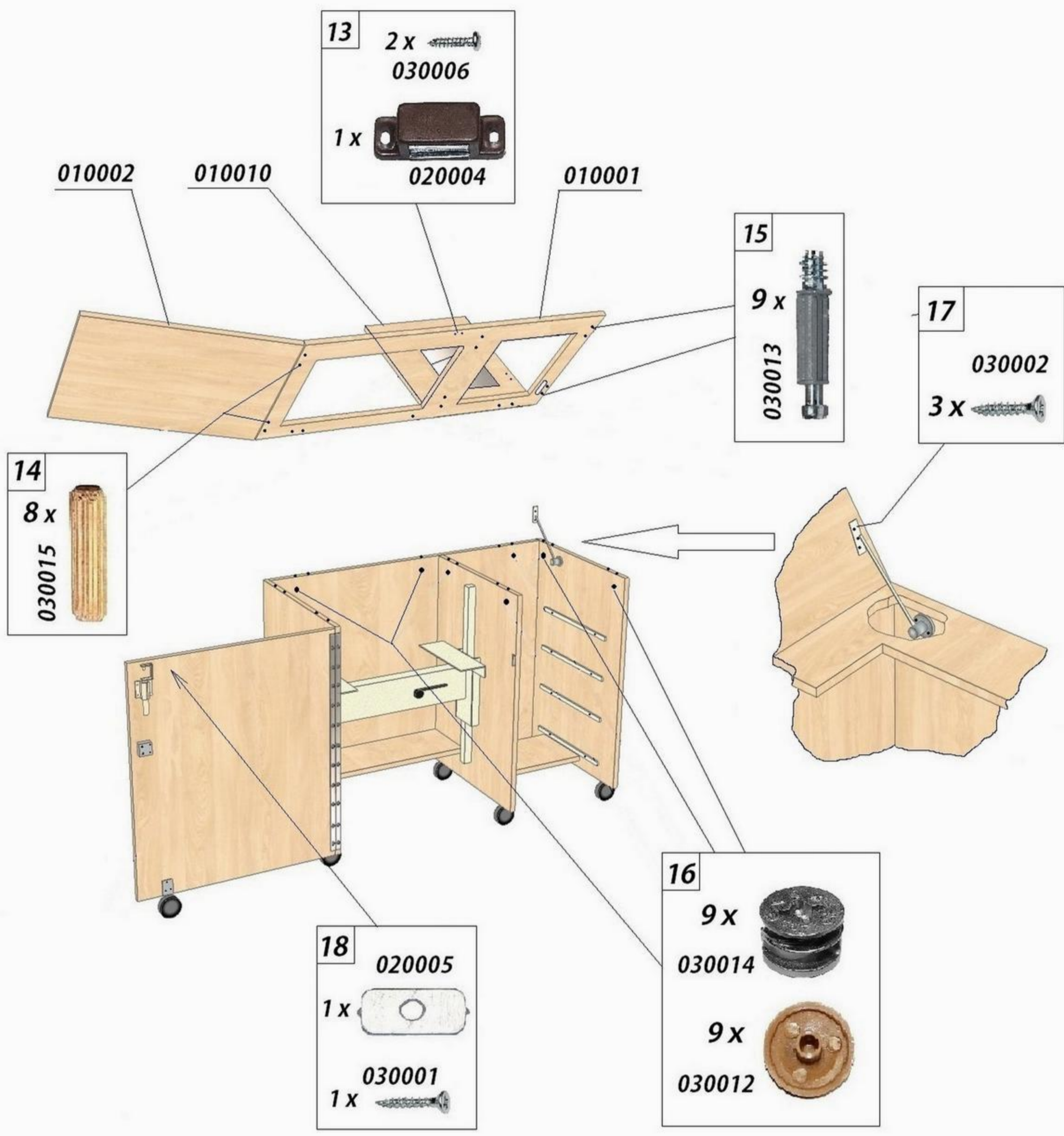



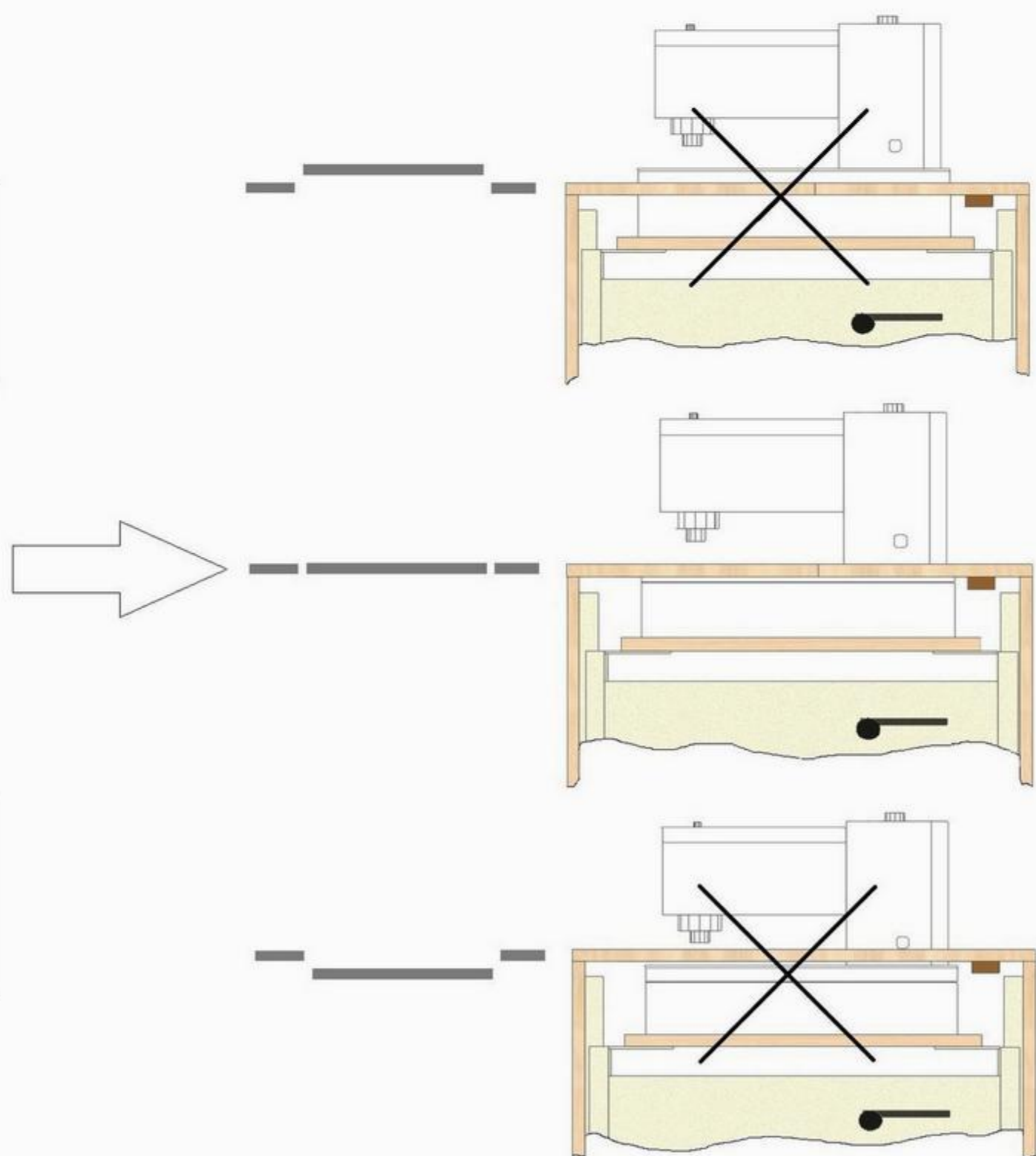
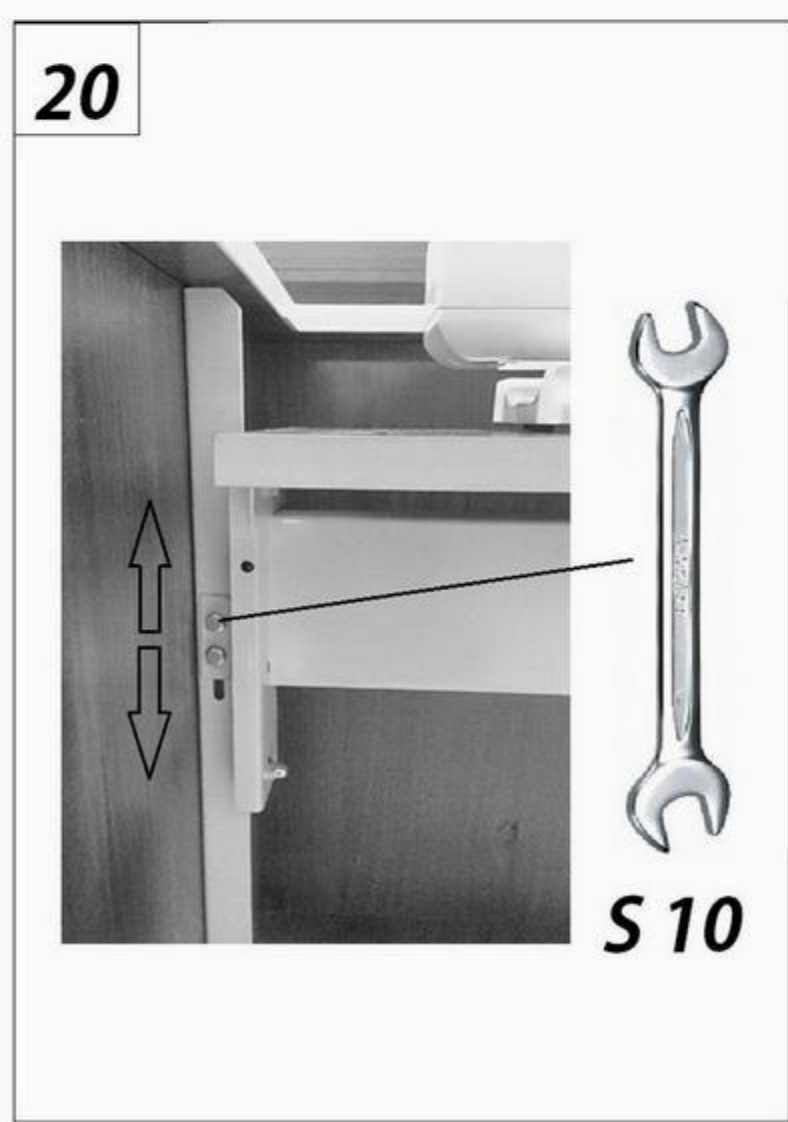
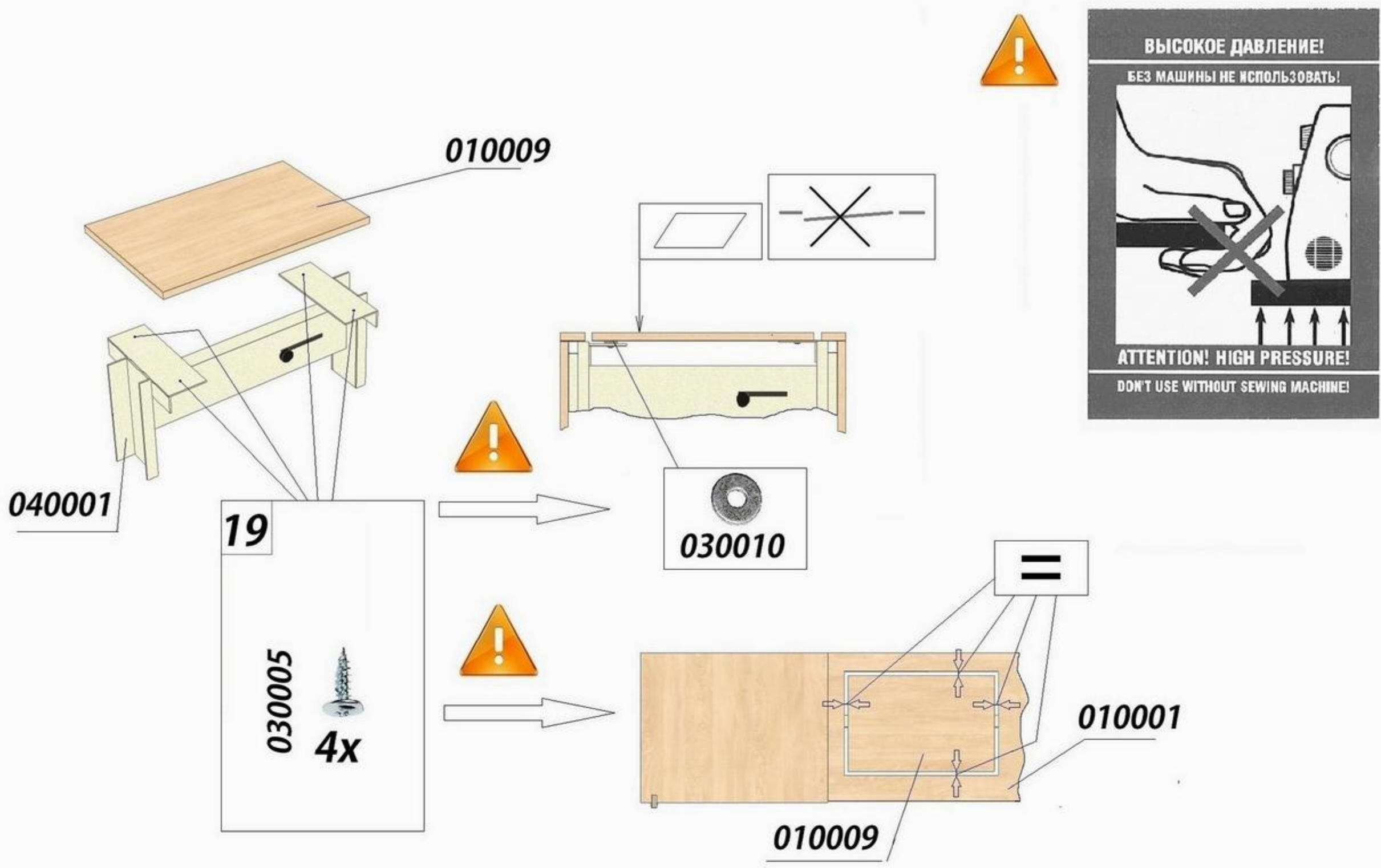





**25**

6x 030001

3x 020015 DR

030016 **22**

6x

**23** 030002

6x

3x 020016

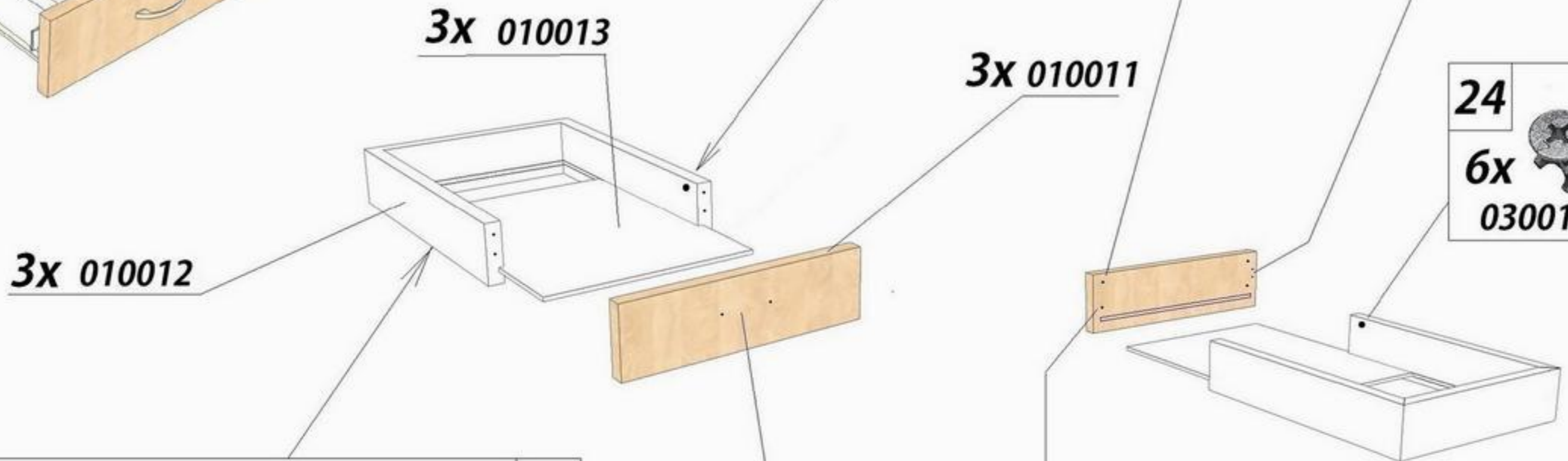

**24**

6x 030017

**25**

3x 020015 DL

6x 030001

**26** 030009 030008

6x 6x

3x 020006

**21** 030015

6x

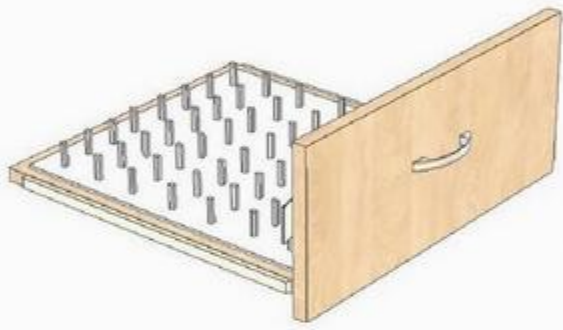

**27** 030002

4x

1x 050004

**30**

030001

2x

1x 020015 DR

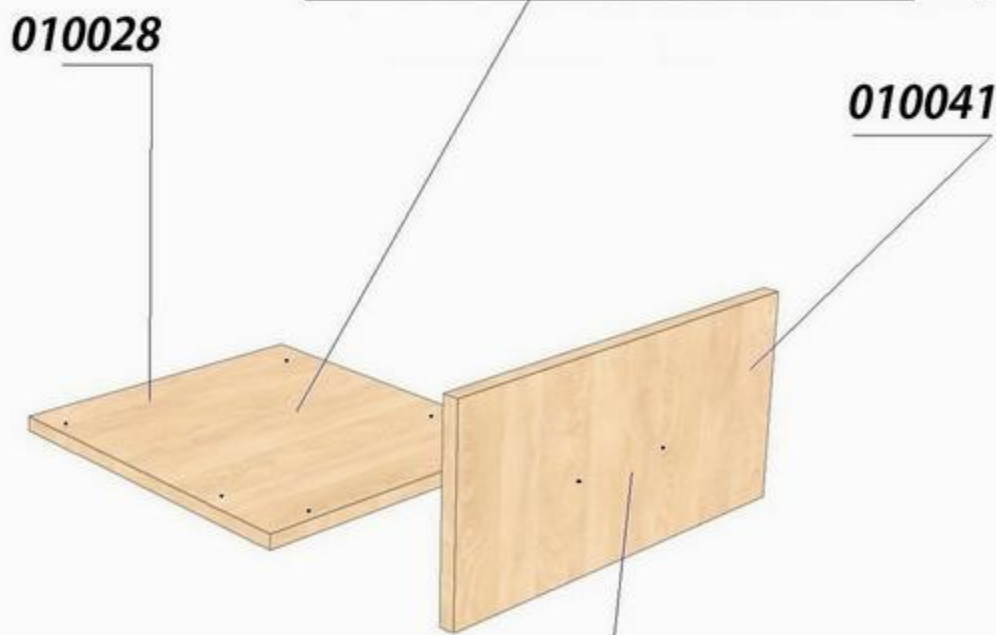

**28** 030002

2x

1x 020016

**31** 030003

2x

**29** 030027 030008

2x 2x

1x 020006

**30**

030001

2x

1x 020015 DL



**33**

1x 050003      2x 050002      4x 030005

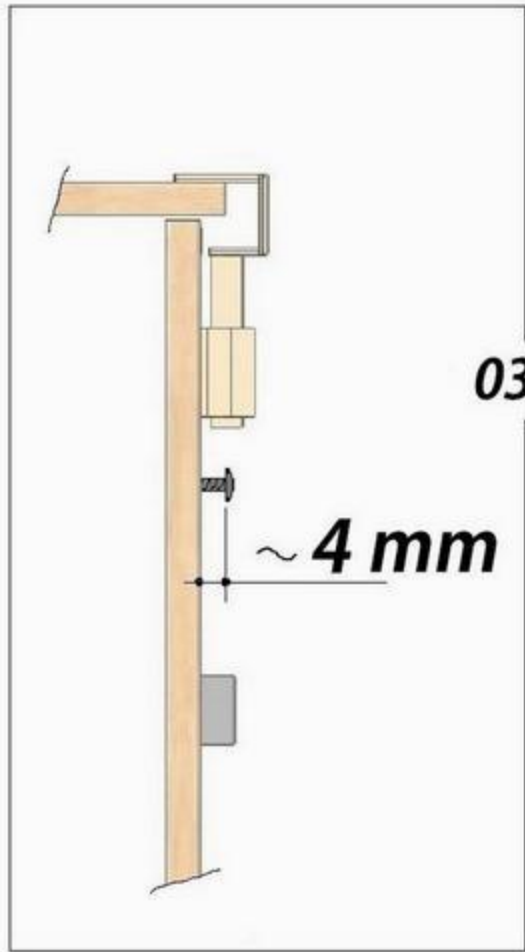
030005

1x 050006

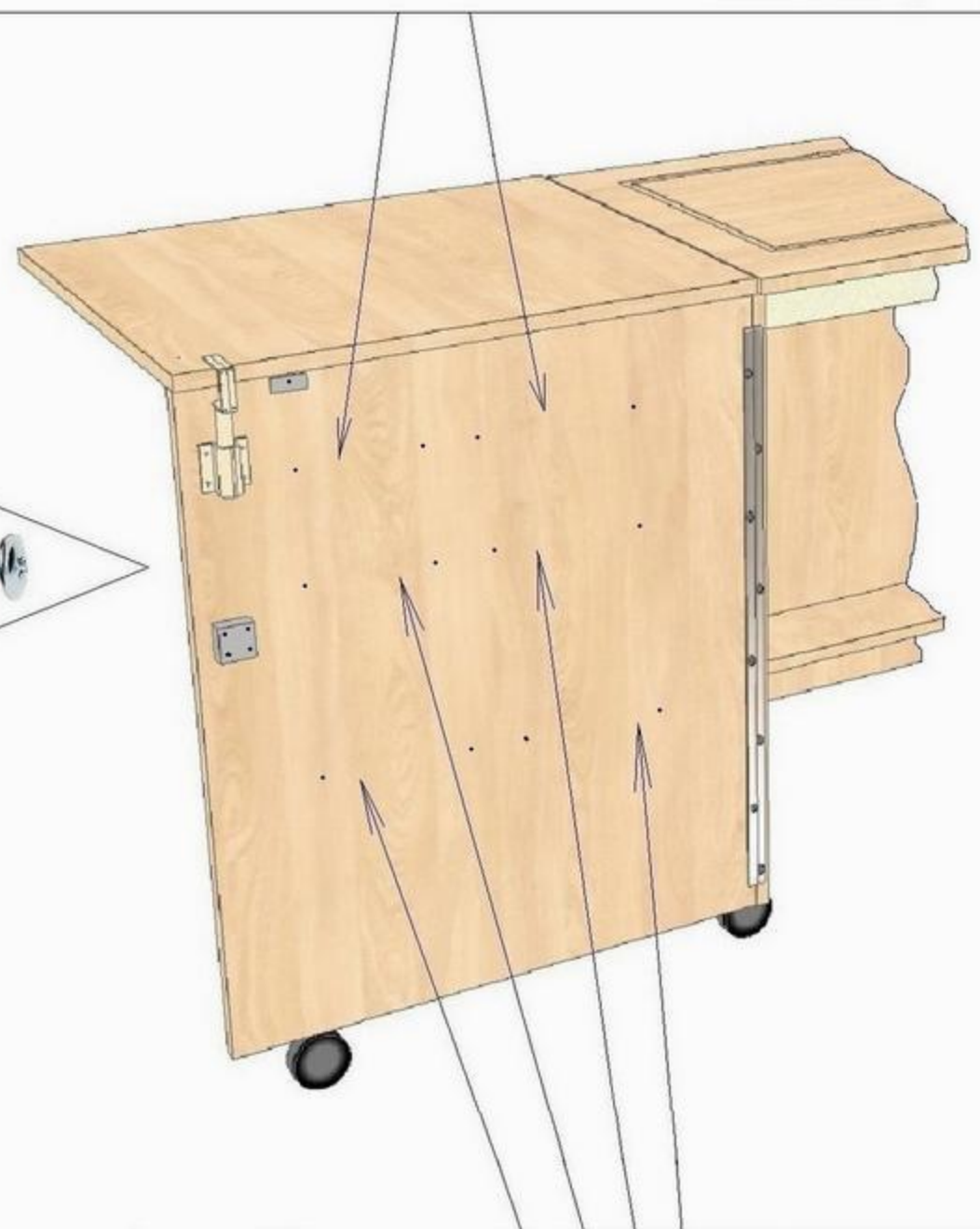

**32**      4x 050001

030005  
8x